

Data Sheet

SSM Floor Heating Manifold

Application

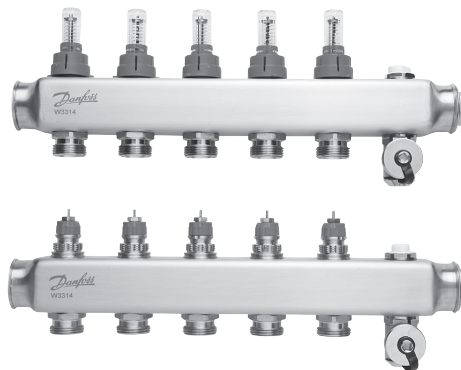

The SSM manifold is used for controlling water flow in under floor heating systems. Each tube of the floor heating system is connected to the manifold, thus making it possible to control water flow or heat supply to each room in the building individually.

The manifold consists of a supply and return manifold. The supply manifold includes possibility for individual shut-off of each circuit on flowmeter or shut-off valve. The return manifold is equipped with integrated Danfoss presetting valves securing optimal hydraulic balance in the system.

The valves can be controlled electronically by thermal actuators or act as self-acting units by means of remote temperature adjusters.







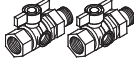

The manifold is supplied in modules of up to 12 outlets. Ball valves are available as an option for positive shut-off between manifold and system.

The SSM manifold is supplied with a manual air-vent and a purge valve.



Ordering

Description	Type	Code no.
	Manifold set 2+2, with flowmeter	SSM-2F 088U0752
	Manifold set 3+3, with flowmeter	SSM-3F 088U0753
	Manifold set 4+4, with flowmeter	SSM-4F 088U0754
	Manifold set 5+5, with flowmeter	SSM-5F 088U0755
	Manifold set 6+6, with flowmeter	SSM-6F 088U0756
	Manifold set 7+7, with flowmeter	SSM-7F 088U0757
	Manifold set 8+8, with flowmeter	SSM-8F 088U0758
	Manifold set 9+9, with flowmeter	SSM-9F 088U0759
	Manifold set 10+10, with flowmeter	SSM-10F 088U0760
	Manifold set 11+11, with flowmeter	SSM-11F 088U0761
	Manifold set 12+12, with flowmeter	SSM-12F 088U0762
		Manifold set 2+2
Manifold set 3+3		SSM-3 088U0803
Manifold set 4+4		SSM-4 088U0804
Manifold set 5+5		SSM-5 088U0805
Manifold set 6+6		SSM-6 088U0806
Manifold set 7+7		SSM-7 088U0807
Manifold set 8+8		SSM-8 088U0808
Manifold set 9+9		SSM-9 088U0809
Manifold set 10+10		SSM-10 088U0810
Manifold set 11+11		SSM-11 088U0811
Manifold set 12+12		SSM-12 088U0812

Accessories

Description	Type	Code no.
 Mounting brackets set	SSM-MB	088U0596
 2 x ball valve 1" — for connection to manifold and for blocking of floor heating system	FHF-BV	088U0822
 1 x thermometer (0 °C to 60 °C) Ø 35 mm — for flow/return temperature measurement	FHD-T	088U0029
 Union, 1"	—	088U0820
 Replacement valve for manifold	—	013G7376
 Reducing Bush	FHF-R	088U0584
 Connection piece	FHF-C	088U0583
 Flowmeter	—	088U0819
	Thermal actuator, 24V, NC, Danfoss RA connection to valve	TWA-A 088H3110
	Thermal actuator, 230V, NC, Danfoss RA connection to valve	TWA-A 088H3112
	Thermal actuator, 24V, NC, with end switch, Danfoss RA connection to valve	TWA-A 088H3114
 Stuffing box for manifolds	DZR	013G0554

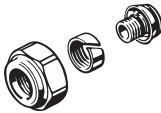
Compression fittings

Description	Type, mm	Code no.
 <p>Compression fittings for PEX tubing in accordance with ISO 15875.</p> <p>Max working pressure: 6 bar Test pressure: 10 bar Max. flow temperature: 95 °C G 3/4" internal thread</p> <p>Max. flow temperature given by the tube manufacturer must not be exceeded.</p>	12 x 2	013G4152
	13 x 2	013G4153
	14 x 2	013G4154
	15 x 2,5	013G4155
	16 x 1,5	013G4157
	16 x 2	013G4156 ¹⁾
	16 x 2,2	013G4163
	17 x 2	013G4162
	18 x 2	013G4158
	18 x 2,5	013G4159
	20 x 2	013G4160
	20 x 2,25	013G4093 ¹⁾
20 x 2,5	013G4161	
 <p>Compression fittings for ALUPEX tubing.</p> <p>Max working pressure: 6 bar Test pressure: 10 bar Max flow temperature: 95 °C G 3/4" Internal thread</p> <p>Max flow temperature given by the tube manufacturer must not be exceeded.</p>	12 x 2	013G4182
	14 x 2	013G4184
	15 x 2,5	013G4185
	16 x 2	013G4186 ²⁾
	16 x 2,25	013G4187
	18 x 2	013G4188
	20 x 2	013G4190
	20 x 2,25	013G4093 ²⁾
	20 x 2,5	013G4191

¹⁾ Compression fittings also suitable for **PERT** tubing in accordance with ISO 15875.

²⁾ Compression fittings also suitable for **PERT/ALU/PERT** tubing.

Capacity/commissioning

The pre-setting of the manifold valves determines the flow in the floor heating tubes and is therefore an important factor for obtaining optimal hydraulic balance in the system.

A correct hydraulic balance is important if optimal comfort shall be achieved with a minimum of energy consumption and is easily carried out following the example shown below.

Example

Room 1:	1. Determine longest tube/largest room	25 m ²
	2. Desired cooling (Δt)	5 °C (typical)
	3. Determine heat requirement for the room	50 W/m ²
	4. Conversion factor	1,16
	5. Calculation of flow for the room	$Q \text{ (l/h)} = \frac{50 \text{ W/m}^2 \times 25 \text{ m}^2}{5 \text{ °C} \times 1,16} = 216 \text{ l/h}$
Room 2:	6. Determine area for the next room	15 m ²
	7. Calculation of flow for the room (Δt and heat requirement is assumed identical for the rooms in this case)	$Q \text{ (l/h)} = \frac{50 \text{ W/m}^2 \times 15 \text{ m}^2}{5 \text{ °C} \times 1,16} = 129 \text{ l/h}$

Manifold, with flowmeter

Pre-setting:
Room 1 → N
Room 2 → 5

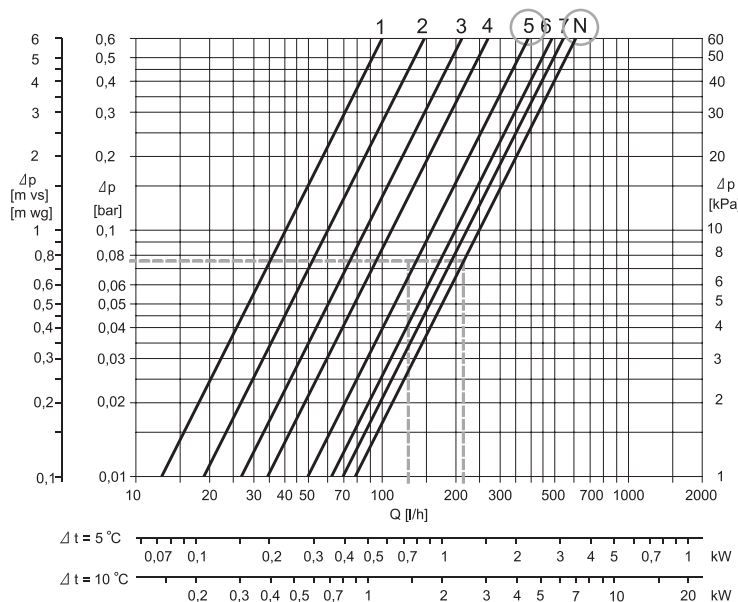

Manifold, without flowmeter

Pre-setting:
Room 1 → N
Room 2 → 6

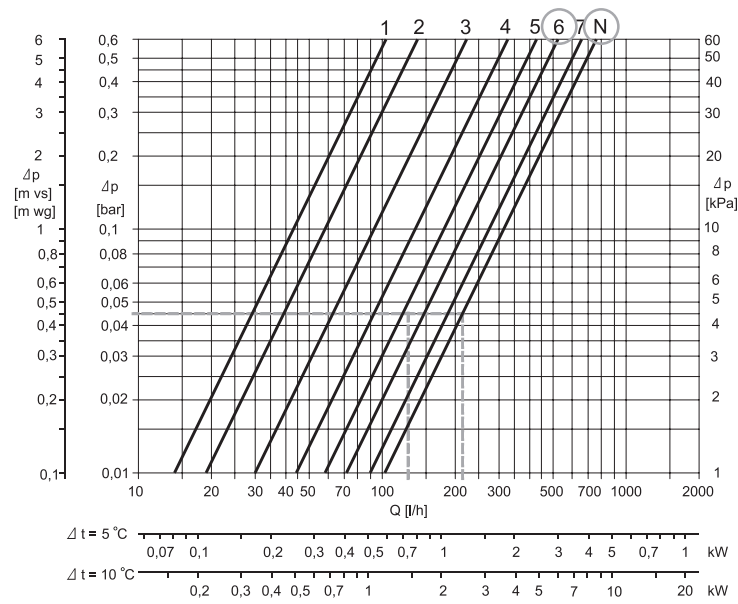

Presetting the manifold valves

The diagram shows the capacities for each heating circuit at different presettings of the manifold valves.

Based on the above calculations and capacity diagram each manifold valve is preset by rotating the red ring until the correct value on the ring is in-line with the sight mark on the valve.

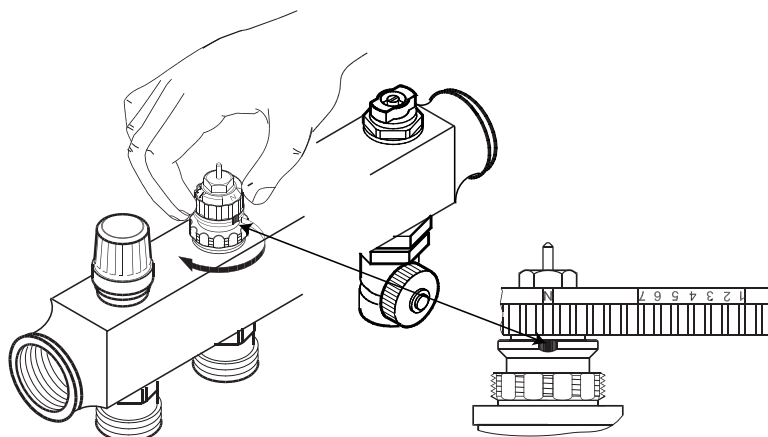

Operation conditions

	Supply manifold with flowmeter	Supply manifold without flowmeter
Max differential pressure	0,6 bar	0,6 bar
Max working pressure	6 bar	10 bar
Max test pressure	10 bar	16 bar
Max flow temperature	90 °C	90 °C

System layout

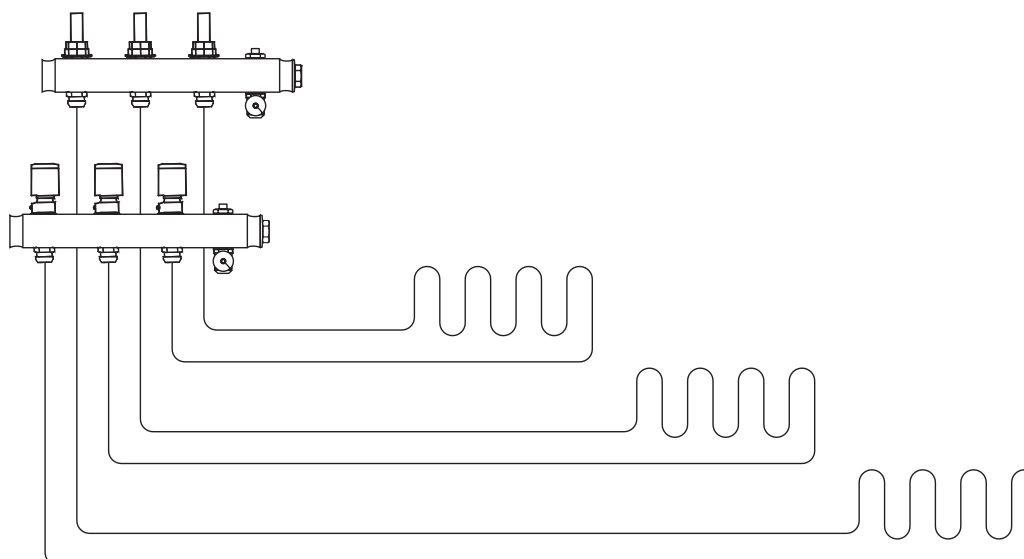

Dimensions

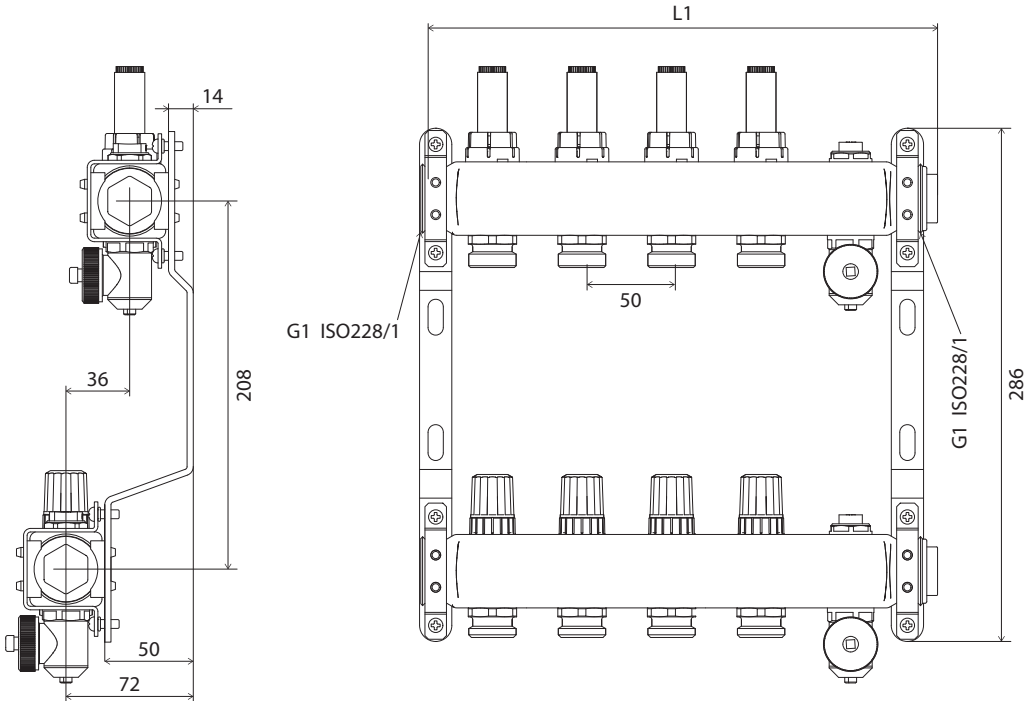

Type	2+2	3+3	4+4	5+5	6+6	7+7	8+8	9+9	10+10	11+11	12+12
L1 (mm)	190	240	290	340	390	440	490	540	590	640	690

Danfoss Limited
 Heating Segment • danfoss.uk • +44 (0)1895 617000 • E-mail: customerservice.uk@danfoss.com

Danfoss can accept no responsibility for possible errors in catalogues, brochures and other printed material. Danfoss reserves the right to alter its products without notice. This also applies to products already on order provided that such alterations can be made without subsequential changes being necessary in specifications already agreed. All trademarks in this material are property of the respective companies. Danfoss and all Danfoss logotypes are trademarks of Danfoss A/S. All rights reserved.